



English



www.rhinosupply.nl

Selwood Pumps

“Selwood Pumps is proud to deliver to you the highest quality contractors pumps, supported world wide by local partners committed to outstanding levels of service”

SELWOOD
www.selwoodpumps.com

We are Selwood

Selwood represents the international benchmark in pumping solutions. Our products are in operation around the globe and are synonymous with quality, longevity and reliability.

Our status as both a manufacturer of pumps and the number one pump rental provider in the UK puts us in a unique position in the international market.

Every pump we sell is designed by Selwood to endure the rigours of rental, supported by decades of research, development and experience in the water, environmental and construction industries.

Our international network of strategic partners share our passion for the very best in product design, expertise and customer service, coupled with the highest level of support and aftersales care.

Selwood's people are proud of the company's 70-year heritage and committed to remaining at the cutting edge of pumping solutions technology around the world. We are proud to present our range to you.

Selwood – Product excellence. Passionate about service. Proud to deliver.

RHINO
SUPPLY

www.rhinosupply.nl



Unique priming system

Selprime - Is Selwood's own designed unique patented priming system that utilises a water tolerant diaphragm air pump.

This is an environmentally friendly design that has none of the oil vapour emissions and oil emulsifications associated with other priming systems.

Selwood's status as a renowned pump manufacturer and the number one pump rental solutions provider in the UK means we are in a unique position in the international sales market.

Our products are designed for the rigours of rental, supported by decades of innovation, research and development.

Selwood customers are therefore assured of the quality, longevity and durability of each and every pump we sell across the range, including solids handling, high volume drainers, high head, hydraulic submersible, chopper and positive displacement pumps.

At Selwood we never settle for second best – and neither should you. This is what sets us apart from the rest.

Exceptional Customer Service

Our UK teams and worldwide network of partners provide exceptional customer service and a pride that comes from our world-renowned products. Our years of experience, specialist knowledge and technical expertise allow us to give you the best service in the business.

We offer a truly bespoke service – we know that the requirements are different for each and every customer and work with you to provide the optimum solution for the job.

Selwood pumps come guaranteed, supported by expertise and passion. We offer site visits, installation and maintenance services backed by our genuine 24/7, 365 days-a-year emergency callout system. Our aftersales service means we can supply spares quickly, when and where you need them and you'll experience peace of mind with our one-year warranty.

Performance Engineered. British-made.

Selwood's unparalleled commitment to quality has ensured our position as leaders in the development and manufacture of outstanding pumps.

Our original Selprime design is often imitated, but never bettered. This automatic self-priming system features a water tolerant diaphragm air pump, rapid prime and re-prime, and is an environmentally friendly solution – with no oil vapour emissions or oil emulsification. It's incredibly simple to maintain and repair.

We also supply the latest emissions-compliant engines to anywhere in the world. Years of global experience and our international distributor network make us sympathetic to territories with differing regulations. You can trust our local experts.

We use the best materials for the job. A number of our models can be made with stainless steel interiors; robust and highly resistant to abrasion and corrosion. Other pump internals are heat treated to make them even tougher – perfect for aggressive environments such as quarries or mines. Whatever the job, we have the solution.

Always Cost-Efficient

Our pumps are easy to maintain and can be repaired on site, giving you less downtime when it really matters. What's more, the robust construction and dry running capability means they're durable, reliable and cost less over their life cycle.

Close-coupled pump design ensures ease of maintenance and repair with reduced noise, vibration and extended coupling life.

You'll also find a great deal of commonality between spares across our pump ranges, simplifying the requirement for spare parts.





Body unit or complete pump

Our pumps are flexible to fit your needs. Choose to purchase just a bare shaft or close-coupled pump, or the complete pump unit options.



Diesel engines

Our diesel pumps are fully portable and self-contained, so offer reliability, efficiency and availability no matter how isolated your site. We buy the highest quality engines, using brands such as CAT, Perkins, Deutz, Isuzu and Yanmar, offering support around the world. These diesel engines meet the latest emission legislation for non-road mobile machinery, so rest assured that you have the cleanest engine technology working for you.



Electric motors

Our efficient electric motor options give you the choice of temporary or permanent installation, where electric power sources exist. Our electric pumps ultimately save money by cutting down on operating and regular maintenance costs when used frequently – not to mention reduced emissions. Like all of our pumps they're long lasting, durable and meet the performance of our diesel-powered models.



Chassis options

We offer a range of flexible chassis variations depending on your site and application. Choose from our skid, Super Silent, wheeled site chassis, road tow and static options; bespoke solutions for the environment you're working in. As a global company, we can offer regional variations packaged locally by our expert distributors.



Super Silent

When you're operating around the clock, particularly in urban and residential areas, noise is a primary concern. We offer the quietest pumps on the market today, with our Super Silent canopies giving world-leading sound attenuation on both electric and diesel motors. Our compact canopies are built to an extremely high technical standard, with protective enclosures and silencers designed to reduce operating noise. Our Super Silent options also offer protection against the elements and added security against theft or vandalism.



SUPPLY

www.hindsonsupply.nl



Nationwide UK Rental network



Highly qualified workforce



Control panels

Choose from a range of specialist control systems, relevant to your requirements. Our auto stop/start solution means that no onsite supervision is required - saving on both fuel and labour. Our remote monitoring pump telemetry provides you with valuable information on pump performance. Data reporting and alarms sent to any device provide peace of mind on un-manned operations.



Oil drain kit

Our time saving oil drain kit offers speedy servicing and maintenance, with clean and quick oil changing facilities for both the pump and engine. This is serviceability in one handy kit.



Chalwyn valves and spark arresters

Additional safety features for peace of mind. Add a Chalwyn valve to stop the engine, should flammable or combustible gasses or hydrocarbon vapour get into your diesel engine. Attach a spark arrester to the diesel engine in hazardous areas or environments where a stray spark could cause ignition of combustible materials.



Bulk fuel kit

Add our bulk fuel kit and you won't need to replenish fuel every day, making operations cleaner and easier. Hook it up to your auxiliary fuel cube and it'll bulk deliver; offering cost and labour efficiency.



Genuine spare parts

With Selwood you have peace of mind in the unlikely event of a breakdown. Spares are readily available from head office, our branches and from our worldwide distributors. Or you can purchase our recommended spares kits - with one and two-year options - so you have access to spares immediately, should you need them.



Hose & fittings

Our range of hoses, pump hose accessories and fittings make us a one-stop-shop for all your pumping needs. We offer hoses and pipes, from 50mm to 300mm, including fire, flexible composite, galvanised steel, HDPE, lay-flat, oil master, poly and wire-armoured hose. Fittings include Bauer, camlock and flange fittings, flow metres, strainers and valves.



Road ramps

Our Selwood-manufactured road and pedestrian access ramps keep people moving by offering a solution to pumping across roads and pavements. They're easy to use, quick to deploy and ultimately reduce cost and re-routing logistics.



Training

We offer comprehensive training for end users and distributors, as well as our own staff and rental teams. We can offer structured or bespoke training programmes at our new technical training centre and classroom at Selwood's head office, or we can come to you - wherever in the world you might be.



Worldwide distributor network



Technical Expertise

Solids handling 'S' pumps

Our 'S' pumps are the market-leader when it comes to solids handling.

The vortex-flow design, Selprime® automatic self-priming, emission compliant engines and ease of operation means trouble-free pumping of

- S** raw and screened sewage
- S** sludge or slurry
- S** bentonite
- S** water with fine and large solids
- S** water containing rags and fibres

Industries that find our Solids Handling Pumps invaluable include water & waste water, construction and civil engineering, oil and gas, pollution control and industrial settings.

The S100, S150 and S200 are our signature Seltorque vortex flow pumps. Choose the S150M for a medium head pump with stainless steel internals and a semi-open two blade impeller, or the S300 for a medium head mixed flow two blade impeller.

The WD150S is a value-engineered option for lesser regulated areas.



Our proven design is perfect for demanding waste & wastewater industries

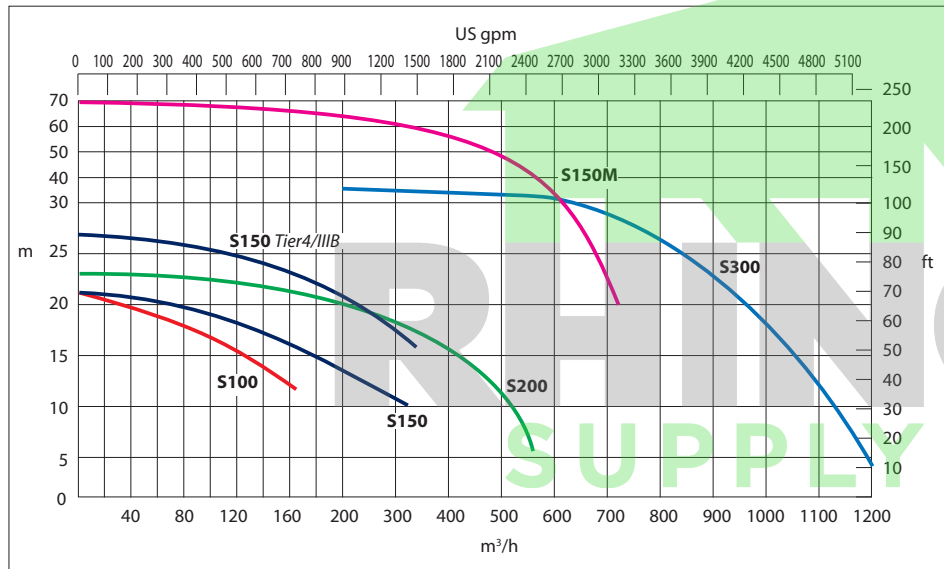

Curves shown are for diesel engines only. Electric motor curves may be different. See appropriate data sheet for specific pump.

www.rhinosupply.nl

Model	Capacity m³/h	Total Head m	Solids Size mm	Self Priming Lift m	Air Handling l/s	Power Required kW	Pump Speed rpm	Inlet / Outlet mm
S100	165	21.3	75	8.8	24	16	1600	100
S150	300	21.3	100	8.8	24	32	1600	150
S150 Tier4/IIIB	310	27	100	8.8	24	32	1800	150
S150M	720	70	76	8.8	24	95	2000	200 / 150
S200	560	23	100	8.8	24	42	1600	200
S300	1200	37	100	8.8	24	68	1500	300
WD150S	300	21.3	100	8.8	24	32	1600	150



High volume drainer 'D' pumps

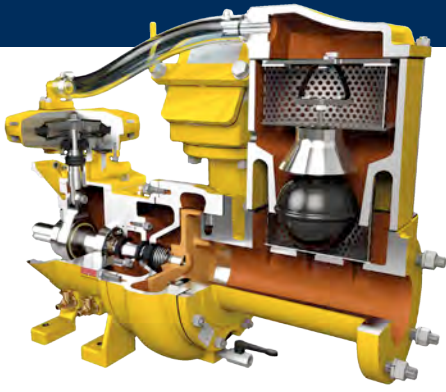

Proven efficiency in construction & civil engineering

Our 'D Pumps' offer high efficiency centrifugal pumps for high-volume fluid transfer.

Handling flows of up to 600m³/h, these highly efficient Selprime® pumps offer emission compliant engines, are easy to operate and maintain and have a robust construction.

Perfect for use with

- S** water – clean, with fine or larger solids
- S** screened sewage

Industries that favour our Drainer range include construction and civil engineering, water and wastewater, quarry and mining, municipal, emergency flood response and industrial.

Our standard range of high-volume drainers includes the D75, D80, D100, D150 and D200. Choose the D150WP for wellpoint dewatering or the D150R for rapid-response emergency use.

The WD150D is a value-engineered option for lesser regulated areas.

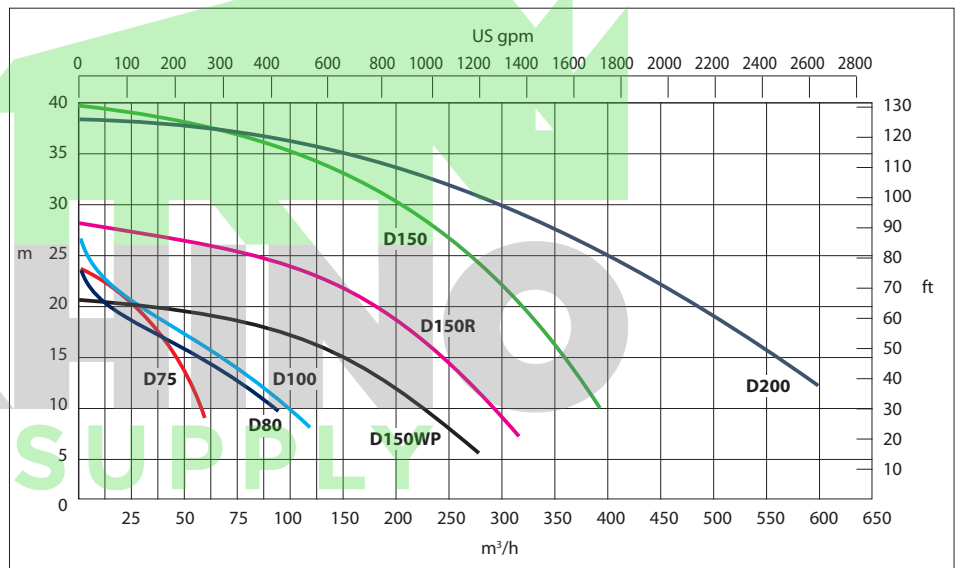

Curves shown are for diesel engines only. Electric motor curves may be different. See appropriate data sheet for specific pump.

www.rhinosupply.nl

Model	Capacity m ³ /h	Total Head m	Solids Size mm	Self Priming Lift m	Air Handling l/s	Power Required kW	Pump Speed rpm	Inlet / Outlet mm
D75	59	23.5	29	8.8	4.25	3.8	2000	75
D80	90	23	29	8.8	4.25	6.5	2000	80
D100	120	26	29	8.8	4.25	6.5	2000	100
D150	380	40.5	45	8.8	24	28	2000	150
D150WP	275	21	45	8.8	48	12	1500	150
D150R	315	27	45	8.8	24	17	1750	150
D200	600	37.5	55	8.8	24	42	1500	200
WD150D	380	40.5	45	8.8	24	28	2000	150

High head 'H' pumps

Our 'H Pumps' offer maximum performance and efficiency for high head, high pressure dewatering.

These efficient models offer total heads up to 158m, mechanical shaft sealing, Selprime® automatic self-priming and emission compliant engines. Ideal for high head and high pressure applications, they're simple to operate and maintain.

Our H Pumps are perfect for

- S** High head dewatering
- S** Pipeline testing & cleaning
- S** Water boosting
- S** High volume jetting
- S** Temporary fire pumps

The High Head range operates best in quarry and mining, construction and civil engineering, ground stabilisation and piling, oil and gas and industrial settings.

Our H80, H100, H150 and H200 are standard Selwood manufactured models with cast iron construction. Choose the H100, H150 and H200 if you need a higher abrasion resistance – these are available with ADI impellers and wear plates for resistance up to 380 BHN.

The H100HM, H150HM and H200HM are hard metal models for the most abrasive jobs.

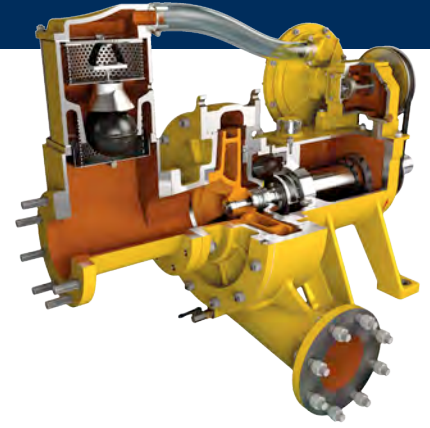

High head pumps designed for mines and quarries

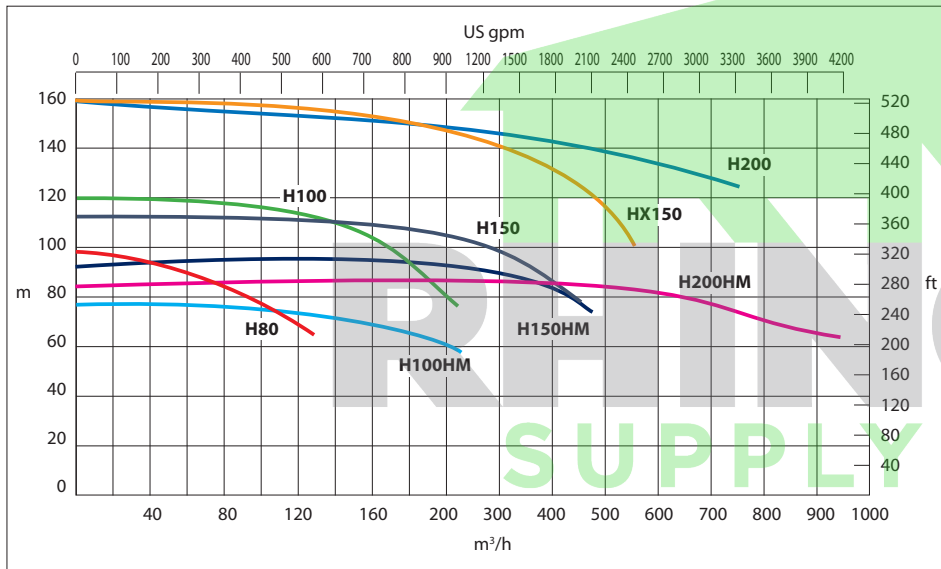

Curves shown are for diesel engines only. Electric motor curves may be different. See appropriate data sheet for specific pump.

www.rhinosupply.com

Model	Capacity	Total Head	Solids Size	Self Priming Lift	Air Handling	Power Required	Pump Speed	Inlet / Outlet
	m³/h	m	mm	m	l/s	kW	rpm	mm
H80	132	98	29	8.8	4.25	30	2000	80
H100	225	120	30	8.8	24	82	2200	100
H150	450	114	30	8.8	24	138	1800	150
HX150	550	160	30	8.8	24	260	1800	150
H200	750	158	45	8.8	24	330	1800	200
H100 HM	225	79	30	8.8	24	87	2200	100
H150 HM	450	95	38	8.8	24	130	1800	150
H200 HM	950	85	60	8.8	24	250	1600	200



Hydraulic submersible 'HS' pumps



Versatile pumps for construction & civil engineering industries

Our 'HS Pumps' are designed for working at greater depths and include a choice of solids, drainer, high head or chopper pumps driven by 10, 20, 35 or 110 HP power-packs.

Options include multiple hydraulic circuits, up to 100m hydraulic hoses, 24hr running and emission compliant engines.

Equally efficient for use with

- S Clean water
- S Water with fine or large solids
- S Water with rags and fibres
- S Raw and screened sewage
- S Sludge or slurry

Our customers include those in the following industries: construction and civil engineering, water and wastewater, ground stabilisation and piling, municipal, industrial, oil spill recovery and pollution control.

50mm pumps are available in aluminium and cast iron construction. 100/150/200mm pumps are all supplied in cast iron for greater durability. Screw pumps feature ADI hard iron internals for superior abrasion resistance.

This range also includes the Seldredge – an innovative, Selwood-engineered hydraulic pump with agitators. It offers the perfect solution for lagoon clearance plus agricultural and environmental clean ups.

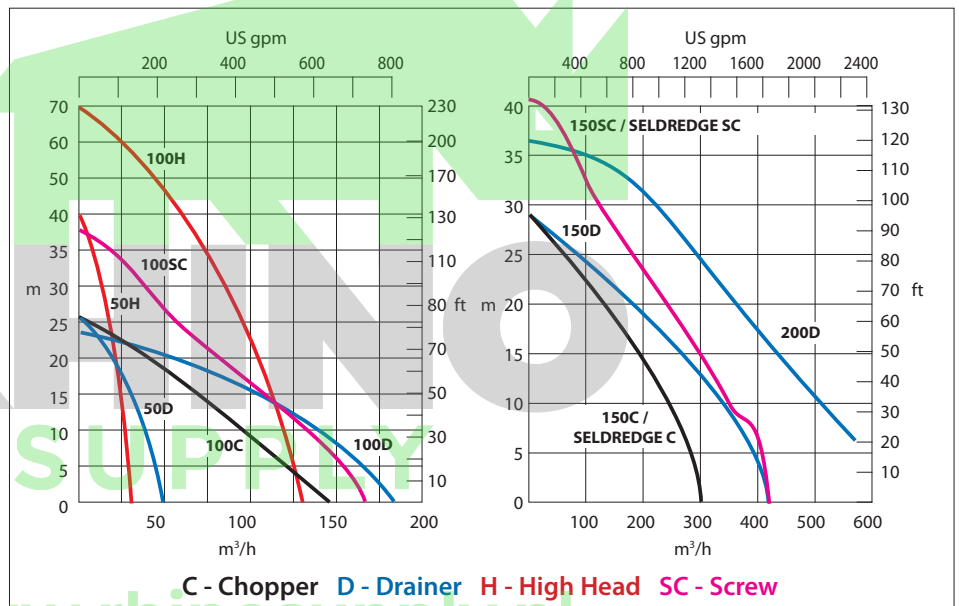

Curves shown are for diesel engines only. Electric motor curves may be different. See appropriate data sheet for specific pump.

Pump End	Capacity	Total Head	Solids Size	Weight	Powerpack	Engine Speed	Hydraulic Flow	Hydraulic Pressure
	m ³ /h	m	mm	kg		rpm	l/min	bar
HS50D	50	26	10	20	HSP10	1793	20	118 - 165
HS50H	27	40	3	20				
HS100C	146	26	50	54	HSP20	1835	30	190 - 244
HS100D	185	23	50	54				
HS100H	130	69	10	54	HSP35	1586-1874	60	155 - 240
HS100SC	165	38	50	54				
HS150C	307	28.5	50	142				
HS150D	420	28.5	75	142	HSP110	1586	20 / 60 / 120	118 - 210
HS150SC	420	41	75	142				
HS200D	575	37	31	250				
Seldredge C	307	28.5	50	620				
Seldredge SC	420	41	75	620				

Chopper 'C' pumps

Our 'C Pumps' offer a non-blocking cutting action for demanding applications.

The hardened chopping impeller can make 3,000 cuts per minute using efficient motors and robust, reliable pumps. The Selprime® automatic self-priming system offers environmental benefits and the whole range is easy to operate and maintain.

Proven performance on

- S** Liquid conditioning
- S** Sludge
- S** Sewage
- S** Organic material
- S** Rags & fibres

Industries using Selwood's Chopper pumps include water & wastewater, industrial and food process.

An original Selwood product, our designs can come with a variety of motor sizes. Electric motors allow for permanent or temporary installation, with priming and non-priming versions. We also offer diesel self priming pumps for temporary applications.

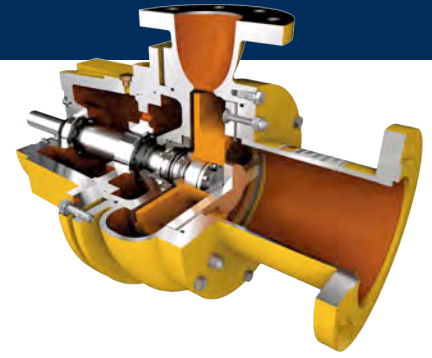

Robust and reliable pumps for wastewater & processes industries

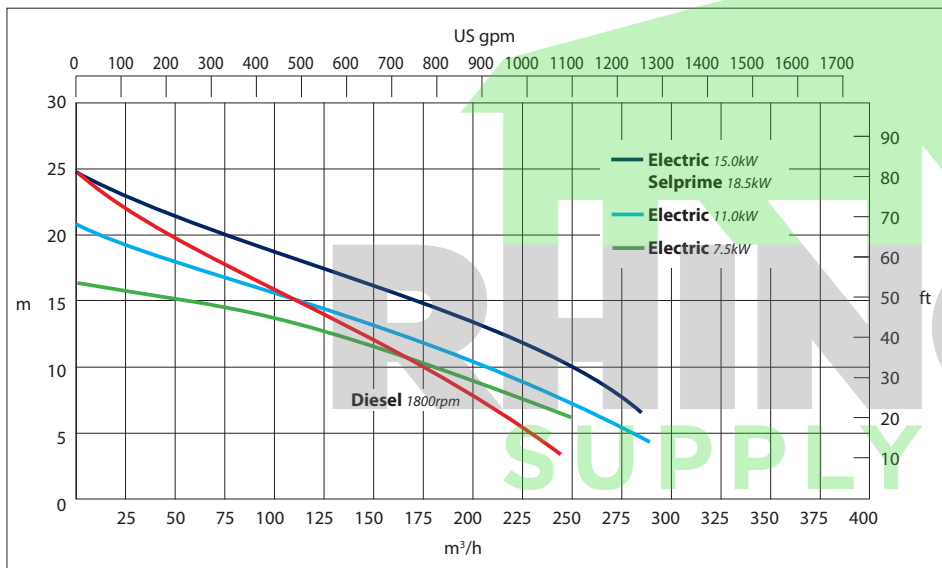

See appropriate data sheet for specific pump.

www.rhinosupply.com

Model	Capacity m³/h	Total Head m	Solids Size mm	Self Priming Lift m	Air Handling l/s	Power Required kW	Pump Speed rpm	Inlet / Outlet mm
C150 Diesel	240	24.5	38	8.8	24	20	1800	150
C150 Electric	250	17	38	-	-	7.5	1440	150
	287	21				11		
	285	24				15		
C150 Electric Selprime	285	24	38	8.8	24	18	1440	150



Positive displacement 'PD' pumps



Frequently used for oil-spill response, recovery & clean-up operations worldwide

Our best-selling 'PD Pumps' feature non-turbulent flows, indefinite dry running & automatic self-priming.

Quality-engineered, these pumps are durable and are easy to operate and maintain.

Applications include

- Viscous liquids
- Oil recovery and skimming
- Light and heavy oils
- Polymers
- Water - clean, dirty or with fine solids
- Wellpoint systems

One of our best-selling models, this is the

pump for oil spill solutions.

Other industries using the PD pumps include pollution control, fire and rescue, oil & gas and ground stabilisation.

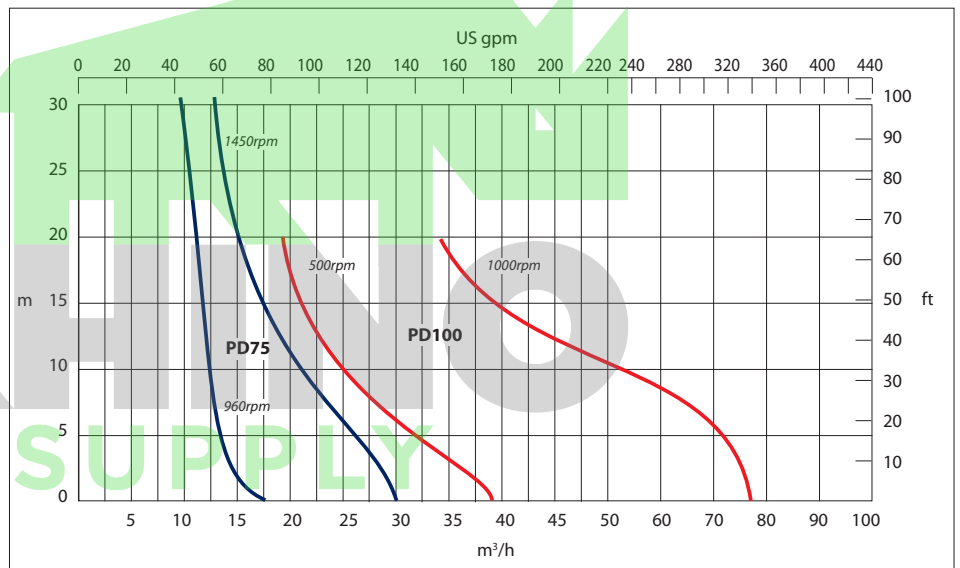
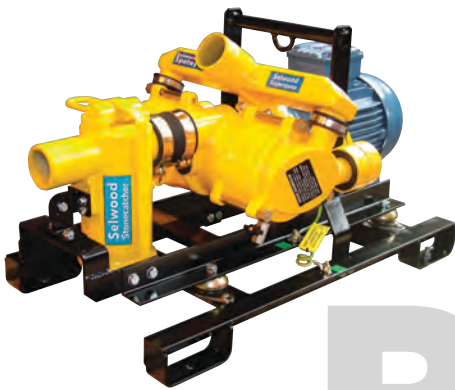

Curves shown are for diesel or petrol engines only. Electric motor curves may be different. See appropriate data sheet for specific pump.

www.rhinosupply.nl

Model	Capacity m ³ /h	Total Head m	Solids Size mm	Self Priming Lift m	Air Handling l/s	Power Required kW	Pump Speed rpm	Inlet / Outlet mm
PD75	30	30.5	6	8.8	3.77	2.5	1450	75
PD100	77	20	16	8.8	11.8	6	1000	100

Worldwide partners

Selwood specialists are proud to deliver outstanding customer service from our worldwide network of distributors.

<p>Algeria</p>  <p>Distribution Matériel Travaux et Pompage www.dmtpt.fr</p>	<p>Colombia</p>  <p>Varichem De Colombia G.E.P.S. www.varichem.com</p>	<p>Hungary</p>  <p>Huntraco Zrt. www.huntraco.hu</p>	<p>Netherlands</p>  <p>Van der Ende Group www.vanderendegroep.nl</p>	<p>Portugal</p>  <p>Perta www.perta.pt</p>
<p>Angola</p>  <p>Perta www.perta.pt</p>	<p>Ecuador</p>  <p>Corena www.corena.com.ec</p>	<p>Indonesia</p>  <p>Sejahtera www.sejahteratridayaprima.com</p>	<p>New Zealand</p>  <p>Youngman Richardson & Co www.yrco.co.nz</p>	<p>Russia</p>  <p>Dattis www.dattis.ru</p>
<p>Australia</p>  <p>Eneraque www.eneraque.com</p>	<p>Egypt</p>  <p>Moshir Co. Email: zakaria@moshircompany.com</p>	<p>Italy</p>  <p>Millars Products www.millarsproducts.com</p>	<p>Nigeria</p>  <p>Emco Oilfield Services www.emcoservices.com</p>	<p>Singapore</p>  <p>Land Equipment www.land-equipment.com.sg</p>
<p>France</p>  <p>Distribution Matériel Travaux et Pompage www.dmtpt.fr</p>	<p>France</p>  <p>Distribution Matériel Travaux et Pompage www.dmtpt.fr</p>	<p>Malaysia</p>  <p>Kwikflow Marketing Email: thyekoon@streamyx.com</p>	<p>Norway</p>  <p>Noren Bergen AS www.noren.no</p>	<p>South Africa</p>  <p>Ian Dickie www.iandickie.co.za</p>
<p>Baltic States</p>  <p>Nemco Sia www.nemcoent.com</p>	<p>Germany</p>  <p>MARCH PUMPEN GmbH www.marchpumpen.de</p>	<p>Mexico</p>  <p>Alpina Briggs Mexicana S. A. De C.V. www.alpinabriggs.com.br</p>	<p>Pump-Service</p>  <p>Pump-Service www.pumpe-service.no</p>	<p>Spain</p>  <p>ABIN - Aplicaciones de Bombeo Industrial S.L. www.abin.es</p>
<p>Brazil</p>  <p>Alpina Ambiental S.A. www.alpinabriggs.com.br</p>	<p>Germany</p>  <p>Söndgerath Pumpen GmbH www.spt-pumpen.de</p>	<p>Morocco</p>  <p>Distribution Matériel Travaux et Pompage www.dmtpt.fr</p>	<p>Philippines</p>  <p>Wildcat Machinery Email: cathy.avila@wildcat.com.ph</p>	<p>USA</p>  <p>Holland Pumps www.hollandpump.com</p>
<p>Chile</p>  <p>Bermad Fluid Solutions www.bfschile.com</p>	<p>Hong Kong</p>  <p>Tower Mark www.towermark.com</p>	<p>Poland</p>  <p>Tech-Pomp Sp. z o.o. www.techpomp.pl</p>	<p>Poland</p>  <p>Tech-Pomp Sp. z o.o. www.techpomp.pl</p>	<p>Pump Wrxs & Controls</p>  <p>Pump Wrxs & Controls www.pumpwrxs.com</p>

SELWOOD
www.selwoodpumps.com

Bournemouth Road
Chandler's Ford, Eastleigh
Hampshire
SO53 3ZL UK

T +44(0) 23 8026 6311
E info@selwood.co.uk